

NEW
IMPROVED BUTTON CONTROLS

FIRST-LIGHT
USA



T-MAX™ LE
USER MANUAL

TABLE OF CONTENTS

Specifications	1
Components	4
Battery Installation	4
Basic Functions	5
Lockout/Ready Mode.....	5
Momentary Mode.....	5
Primary Control.....	6
Secondary Control.....	6
Secondary Color Selection	6
Double-Click for Color	7
Strobe Mode	7
Safety Beacon Mode	8
Low Battery Indication	8
Finger Loop	9
Steel Belt Clip.....	10
Tactical Retention System (TRS)	11
Lifetime Limited Warranty.....	12

FIRST-LIGHT USA, LLC



205 S. Main Street, Seymour, IL 61875





Phone: 877.454.4450 | Fax: 877.454.4420

Email: info@firstlight-usa.com

www.firstlight-usa.com

SPECIFICATIONS

FL1 STANDARD	MAX	HIGH	MEDIUM	LOW
	700 LUMENS	200 LUMENS	80 LUMENS	5 LUMENS
	2h	4h	16h	60h

FL1 STANDARD			
			
3m	1m	211m	11,140cd

Batteries

- (2) CR123 3-Volt Lithium Batteries, ANSI: 5018LC, IEC: CR17345

Environmental Specifications

- Normal Operating Temperatures: (-20°F) to 120°F
- Waterproof

Thank you for purchasing the First-Light USA T-MAX™ LE Tactical Light. Please carefully review this manual prior to use.



IMPORTANT – PLEASE READ FIRST

The intense white light emitted by the primary white LED may cause temporary blinding, regardless of the brightness level used. Use caution during operation. Do not point light directly into eyes at any distance. Not for use by children.



LITHIUM BATTERY WARNING

Lithium batteries can be dangerous if used improperly. Never disassemble, short circuit, recharge, or expose to water, fire, or high temperatures. Never use batteries of different ages, capacities, or brands together. Store separately and properly dispose of batteries after use. Keep away from children.

NOTE: High quality, rechargeable CR123 batteries may be used to power the T-MAX LE Tactical Light. The user should identify the voltage capacity of any rechargeable batteries prior to installing them into the T-MAX LE Tactical Light.



IMPORTANT: Never install any rechargeable CR123 batteries that exceed a combined voltage of 10 volts as this will damage the internal circuitry and void the warranty.

REPLACEMENT PARTS

To order replacement parts, please call 877.454.4450 or visit www.firstlight-usa.com.

COMPONENTS

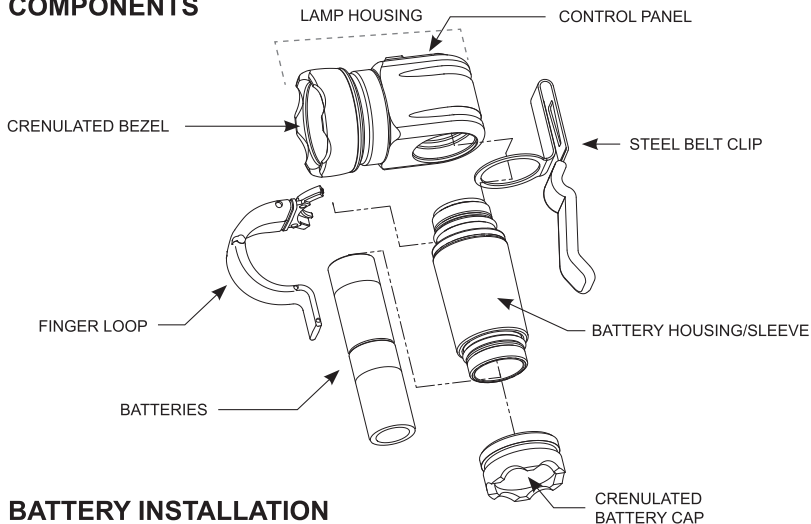

BATTERY INSTALLATION

STEP 1. Remove battery cap. Insert two batteries “+” terminals first (as shown above).

STEP 2. Reinstall battery cap. Hand-tighten until snug.



STEP 3. Ensure batteries are properly installed by pressing any button on the control panel. The red LED “lock” should illuminate indicating the light is in Lockout Mode. If it does not, repeat Steps 1 and 2, ensuring both “+” terminals are facing up.

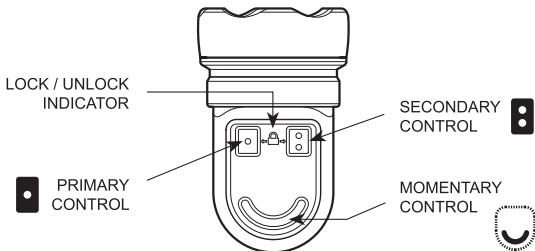

BASIC FUNCTIONS

Control Panel Diagram





LOCKOUT/READY MODE

The T-MAX™ LE is factory-shipped in Lockout Mode, a setting for preventing accidental illumination. To unlock the light and enter Ready Mode, press the  and  buttons simultaneously and release. The green “unlock” indicator illuminates signaling that visible light modes are active.

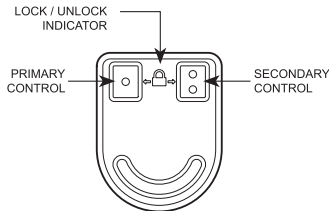
To re-enter Lockout Mode at any time during use, press and hold the  and  buttons simultaneously until the red “lockout” indicator illuminates, then release.



MOMENTARY CONTROL BUTTON

Pressing the  button will turn on the white LED in maximum output. Releasing the  button will turn off the white LED.

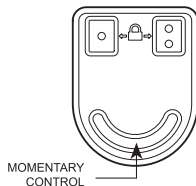

PRIMARY CONTROL BUTTON

To turn on the primary (white) LED, press and release the **1** button. To adjust the brightness of the primary LED, from the on position, press and hold the **1** button. Release the **1** button at the desired brightness. To turn off the primary LED, press and release the **1** button.

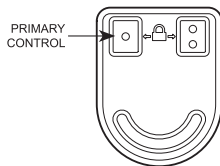

SECONDARY CONTROL BUTTON

To turn on the secondary (color) LEDs, press and release the **2** button. To adjust the brightness of the secondary LEDs, press and hold the **2** button. Release the **2** button at the desired brightness. To turn off the secondary LEDs, press and release the **2** button.

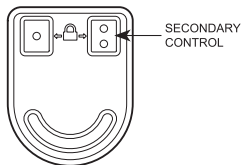

SECONDARY COLOR SELECTION

From the off position, press and hold the **2** button to cycle between the secondary LED color options. Release the **2** button at the desired color.

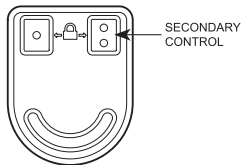

DOUBLE-CLICK FOR COLOR

While in Lockout Mode the colored LEDs can be activated by double-clicking the **■** button. This illuminates the secondary color LEDs in the lowest brightness setting and disables the primary white LED. Adjust the brightness by pressing and holding the **■** button. When the color LEDs are turned off, the light will return to Lockout Mode.

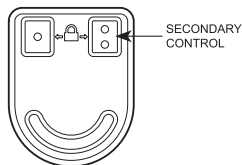



STROBE MODE

To turn on the strobe, press and hold the **○** button with the base of the thumb, then simultaneously press the **■** button with the front portion of the same thumb. Once the strobe is on, the **○** button may be released.

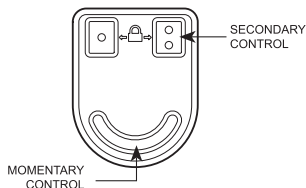
NOTE: Strobe Mode can only be activated as a momentary function.



SAFETY BEACON MODE

To turn on the safety beacon, ensure that the light is in the off position. Press and hold the  button until the safety beacon is activated. To turn off the safety beacon, press and release the  button.

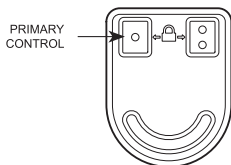

NOTE: White Light Momentary Mode can be activated while the Multi-Color Safety Beacon is in use.

LOW BATTERY

When the battery nears the end of its useful life the red Lock/Unlock indicator will begin to flash. Once the useful life of the batteries has been reached the T-MAX™ LE will begin to limit its output in order to extend run time.

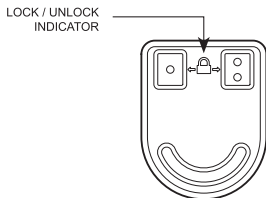

FINGER LOOP

Your T-MAX LE comes equipped with a Finger Loop installed in a neutral/straight-forward position. In order to enhance the ergonomic control of the T-MAX LE, it is recommended that the Finger Loop be slightly offset to better align the thumb with the control panel.

The Finger Loop can be moved by pushing it to the desired position.

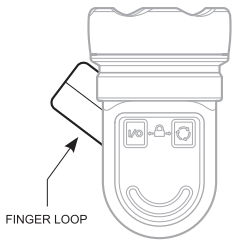

INSTALLING FINGER LOOP

A smaller Finger Loop is also provided. In order to install the smaller Finger Loop, loosen the threaded connection between the lamp housing and battery housing until the large Finger Loop is loosened to a point at which it can be removed. Insert the collar of the smaller Finger Loop so that it is seated within the machined groove located at the top of the battery housing.

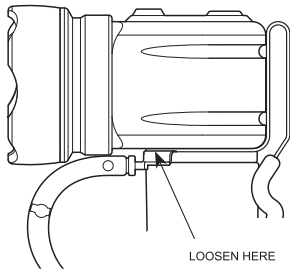

! **IMPORTANT:** Ensure that the Finger Loop remains securely seated during use. Hand-tighten the connection between the battery housing and lamp housing as firmly as possible.

T-MAX™ LE STEEL CLIP (IF EQUIPPED)

The T-MAX LE Steel Clip can be adjusted to any desired position by loosening the connection between the battery housing and the lamp housing to the point where the Steel Clip can be moved.

Move the Steel Clip to the desired position and re-tighten the connection.

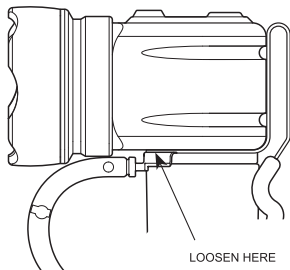

MOLLE/PALS Webbing Attachment

The T-MAX LE MOLLE Steel Clip is specially designed to attaching securely to MOLLE/ PALS webbing. See Figure A to view suggested mounting option.



Figure A: MOLLE Steel Clip attached to MOLLE/PALS webbing

TACTICAL RETENTION SYSTEM (TRS) (IF EQUIPPED)

The Tactical Retention System (TRS) will allow your T-MAX LE to be mounted to a duty belt (maximum width 2.25") for hands-free use. When mounted (see Figure B) to TRS the T-MAX LE can be rotated nearly 180°.

To mount the T-MAX LE to the TRS Receiver, insert the dovetail sleeve on the T-MAX LE's battery housing into the TRS Receiver until a "click" is heard to ensure proper seating. To release, push the spring-loaded button located at the top of the Receiver then slide the dovetail connection free.

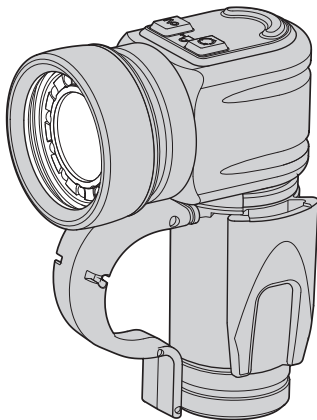

Figure B: Belt TRS Receiver on Duty Belt

FIRST-LIGHT USA, LLC LIFETIME LIMITED WARRANTY

The PERIOD OF WARRANTY shall be for the lifetime of the lighting device from date of purchase. First-Light USA will repair or replace, free of charge, at First-Light USA's option, any part due to defects in materials or workmanship. Certain countries and jurisdictions restrict limited lifetime warranties. If you reside in one of these countries or jurisdictions, First-Light USA extends to you a 10 year limited warranty, which maintains the following terms and conditions.

First-Light USA, at First-Light USA's option, may refund the purchase price to the original owner if unable to make the product perform the work for which it was designed by repair or replacement of a product of at least equal value. The limited warranty contained herein is the purchaser's exclusive remedy.

THIS WARRANTY EXCLUDES damage or defects caused by neglect, abuse, misuse, alteration, disassembly, improper maintenance or accidents. Batteries, or damaged caused by defective or neglected batteries are excluded from this warranty. Accessory items are also excluded from this warranty. Electronics (other than light emitting diodes (LEDs)), are limited to a 3 year warranty with proof of purchase.

To obtain warranty service, call 877.454.4450 or send e-mail to info@firstlight-usa.com.

First-Light USA will then issue a Return Merchandise Authorization (RMA) and instructions on warranty return. The original owner must include the RMA upon returning the product in order to obtain warranty service from First-Light USA.

We will pay to ship the repaired or replaced product to the original owner's address if located within United States. If the original owner's address is located outside of the United States, we will ship the product freight collect.

If we determine the remedy is not covered under this warranty, we will notify you and inform you of service options available on a fee basis.

FIRST-LIGHT USA, LLC MAKES NO OTHER WARRANTY OF ANY KIND, EXPRESSED OR IMPLIED. ALL IMPLIED WARRANTIES, TO INCLUDE BUT NOT LIMITED TO WARRANTIES OF MERCHANTABILITY AND FITNESS FOR A PARTICULAR PURPOSE WHICH EXCEED THE OBLIGATIONS AND TIME LIMITS STATED IN THIS WARRANTY ARE HEREBY DISCLAIMED BY FIRST-LIGHT USA, LLC AND EXCLUDED FROM THIS LIMITED WARRANTY. SOME STATES DO NOT ALLOW LIMITATIONS ON HOW LONG AN IMPLIED WARRANTY LASTS, SO THE ABOVE LIMITATION MAY NOT APPLY TO YOU.

ALSO EXCLUDED FROM THIS WARRANTY ARE ANY INCIDENTAL OR CONSEQUENTIAL DAMAGES INCLUDING LOSS OF USE. SOME STATES DO NOT ALLOW THE EXCLUSION OR LIMITATION OF INCIDENTAL OR CONSEQUENTIAL DAMAGES; EXCLUSIONS MAY NOT APPLY TO YOU.

THIS WARRANTY GIVES YOU SPECIFIC LEGAL RIGHTS AND YOU MAY ALSO HAVE OTHER RIGHTS THAT VARY FROM STATE TO STATE.

FIRST-LIGHT USA, LLC
WARRANTY AND SERVICE DEPARTMENT
205 S. Main Street, Seymour, IL 61875

Phone: 877.454.4450
Fax: 877.454.4420
Email: info@firstlight-usa.com

WHEN YOUR LIGHT DEPENDS ON IT.®

www.firstlight-usa.com