

NEW
IMPROVED BUTTON CONTROLS

FIRST-LIGHT
USA



TOMAHAWK[®] GP

USER MANUAL

TABLE OF CONTENTS

Specifications	1
Components	3
Battery Installation	3
Basic Functions	4
Lockout/Ready Mode.....	4
Momentary Mode.....	5
Primary Control.....	5
Secondary Control	6
Low Battery Indication	6
Finger Loop	7
Steel Belt Clip.....	8
Lifetime Limited Warranty.....	9

FIRST-LIGHT USA, LLC



205 S. Main Street, Seymour, IL 61875





Phone: 877.454.4450 | Fax: 877.454.4420

Email: info@firstlight-usa.com

www.firstlight-usa.com

SPECIFICATIONS

FL1 STANDARD	MAX	HIGH	MEDIUM	LOW
	425 LUMENS	175 LUMENS	50 LUMENS	5 LUMENS
	2h	4h	16h	60h

FL1 STANDARD			
			
3m	1m	220m	12,150cd

Batteries

- (2) CR123 3-Volt Lithium Batteries, ANSI: 5018LC, IEC: CR17345

Environmental Specifications

- Normal Operating Temperatures: (-20°F) to 120°F
- Waterproof

Thank you for purchasing the First-Light USA Tomahawk® GP Tactical Light. Please carefully review this manual prior to use.



IMPORTANT – PLEASE READ FIRST

The intense white light emitted by the primary white LED may cause temporary blinding, regardless of the brightness level used. Use caution during operation. Do not point light directly into eyes at any distance. Not for use by children.



LITHIUM BATTERY WARNING

Lithium batteries can be dangerous if used improperly. Never disassemble, short circuit, recharge, or expose to water, fire, or high temperatures. Never use batteries of different ages, capacities, or brands together. Store separately and properly dispose of batteries after use. Keep away from children.

REPLACEMENT PARTS

To order replacement parts, please call 877.454.4450 or visit www.firstlight-usa.com.

COMPONENTS

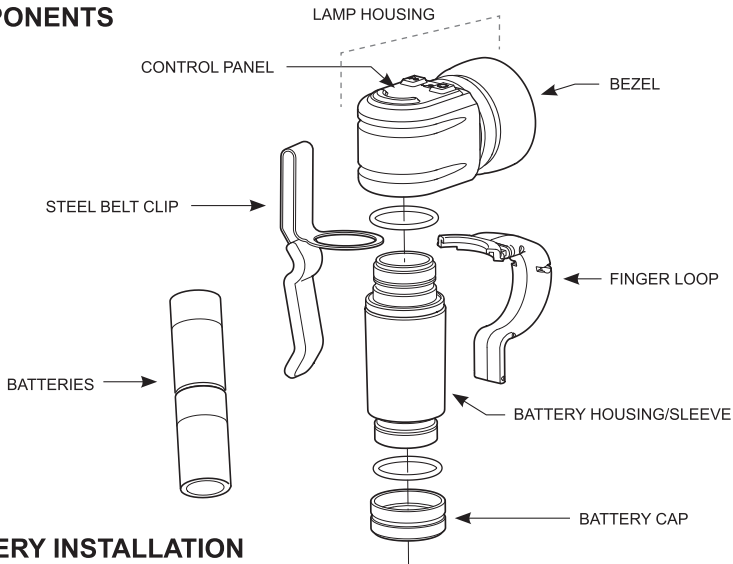

BATTERY INSTALLATION

STEP 1. Remove battery cap. Insert two batteries “+” terminals first (as shown above).

STEP 2. Reinstall battery cap. Hand-tighten until snug.



STEP 3. Ensure batteries are properly installed by pressing any button on the control panel. The red LED “lock” should illuminate indicating the light is in Lockout Mode. If it does not, repeat Steps 1 and 2, ensuring both “+” terminals are facing up.

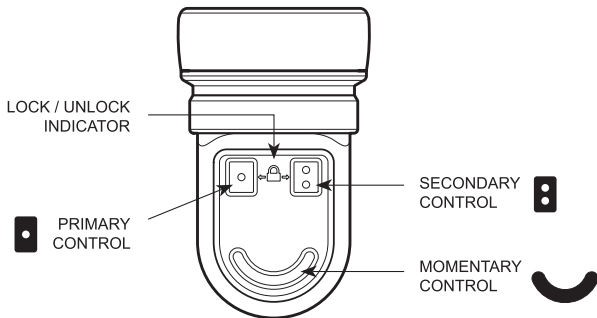

BASIC FUNCTIONS

Control Panel Diagram





LOCKOUT/READY MODE

The Tomahawk® GP is factory-shipped in Lockout Mode, a setting for preventing accidental illumination. To unlock the light and enter Ready Mode, press the  and  buttons simultaneously and release. The green “unlock” indicator illuminates signaling that visible light modes are active.

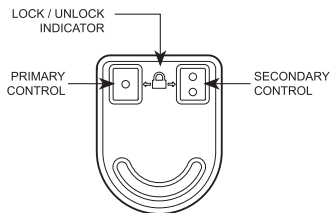
To re-enter Lockout Mode at any time during use, press and hold the  and  buttons simultaneously until the red “lockout” indicator illuminates, then release.





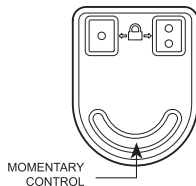

MOMENTARY CONTROL BUTTON

Pressing the  button will turn on the white LED in maximum output. Releasing the  button will turn off the white LED.



PRIMARY CONTROL BUTTON

To turn on the primary (white) LED, press and release the  button. To adjust the brightness of the primary LED, from the on position, press and hold the  button. Release the  button at the desired brightness. To turn off the primary LED, press and release the  button.

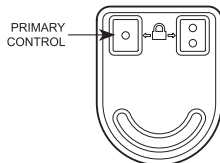

SECONDARY CONTROL BUTTON (LOW MOMENTARY)

Activate Low Momentary by pressing the Secondary Control **B** button. The Low Momentary will activate as long as the Secondary Control **B** button is pressed.

The Low Momentary function can be activated **ONLY** as a momentary function and cannot be locked on.

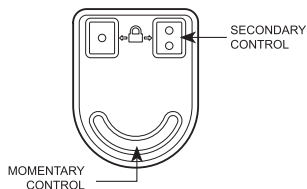

NOTE: Upon exiting Low Momentary mode, the light will default to the last used function.

LOW BATTERY

When the battery nears the end of its useful life the red Lock/Unlock indicator will begin to flash. Once the useful life of the batteries has been reached the Tomahawk® GP will begin to limit its output in order to extend run time.

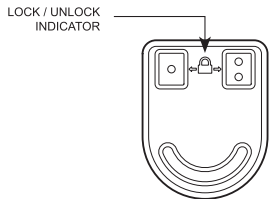

FINGER LOOP

Your Tomahawk GP comes equipped with a Finger Loop installed in a neutral/straight-forward position. In order to enhance the ergonomic control of the Tomahawk GP, it is recommended that the Finger Loop be slightly offset to better align the thumb with the control panel.

The Finger Loop can be moved by pushing it to the desired position.

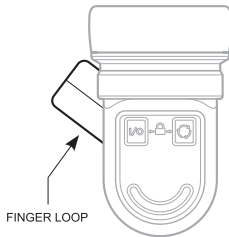

INSTALLING FINGER LOOP

A smaller Finger Loop is also provided. In order to install the smaller Finger Loop, loosen the threaded connection between the lamp housing and battery housing until the large Finger Loop is loosened to a point at which it can be removed. Insert the collar of the smaller Finger Loop so that it is seated within the machined groove located at the top of the battery housing.

! **IMPORTANT: Ensure that the Finger Loop remains securely seated during use. Hand-tighten the connection between the battery housing and lamp housing as firmly as possible.**

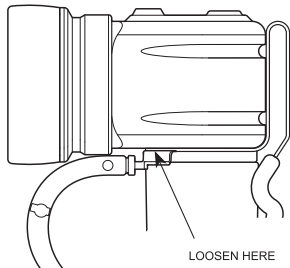

TOMAHAWK® GP STEEL CLIP

The Tomahawk GP Steel Clip can be adjusted to any desired position by loosening the connection between the battery housing and the lamp housing to the point where the Steel Clip can be moved.

Move the Steel Clip to the desired position and re-tighten the connection.

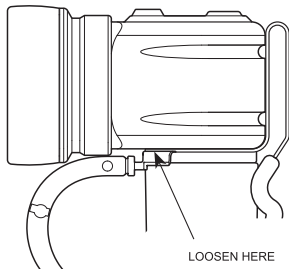

MOLLE/PALS Webbing Attachment

The Tomahawk GP MOLLE Steel Clip is specially designed to attach securely to MOLLE/PALS webbing. See Figure A to view suggested mounting option.



Figure A: MOLLE Steel Clip attached to MOLLE/PALS webbing

FIRST-LIGHT USA, LLC LIFETIME LIMITED WARRANTY

The PERIOD OF WARRANTY shall be for the lifetime of the lighting device from date of purchase. First-Light USA will repair or replace, free of charge, at First-Light USA's option, any part due to defects in materials or workmanship. Certain countries and jurisdictions restrict limited lifetime warranties. If you reside in one of these countries or jurisdictions, First-Light USA extends to you a 10 year limited warranty, which maintains the following terms and conditions.

First-Light USA, at First-Light USA's option, may refund the purchase price to the original owner if unable to make the product perform the work for which it was designed by repair or replacement of a product of at least equal value. The limited warranty contained herein is the purchaser's exclusive remedy.

THIS WARRANTY EXCLUDES damage or defects caused by neglect, abuse, misuse, alteration, disassembly, improper maintenance or accidents. Batteries, or damaged caused by defective or neglected batteries are excluded from this warranty. Accessory items are also excluded from this warranty. Electronics (other than light emitting diodes (LEDs)), are limited to a 3 year warranty with proof of purchase.

To obtain warranty service, call 877.454.4450 or send e-mail to info@firstlight-usa.com.

First-Light USA will then issue a Return Merchandise Authorization (RMA) and instructions on warranty return. The original owner must include the RMA upon returning the product in order to obtain warranty service from First-Light USA.

We will pay to ship the repaired or replaced product to the original owner's address if located within United States. If the original owner's address is located outside of the United States, we will ship the product freight collect.

If we determine the remedy is not covered under this warranty, we will notify you and inform you of service options available on a fee basis.

FIRST-LIGHT USA, LLC MAKES NO OTHER WARRANTY OF ANY KIND, EXPRESSED OR IMPLIED. ALL IMPLIED WARRANTIES, TO INCLUDE BUT NOT LIMITED TO WARRANTIES OF MERCHANTABILITY AND FITNESS FOR A PARTICULAR PURPOSE WHICH EXCEED THE OBLIGATIONS AND TIME LIMITS STATED IN THIS WARRANTY ARE HEREBY DISCLAIMED BY FIRST-LIGHT USA, LLC AND EXCLUDED FROM THIS LIMITED WARRANTY. SOME STATES DO NOT ALLOW LIMITATIONS ON HOW LONG AN IMPLIED WARRANTY LASTS, SO THE ABOVE LIMITATION MAY NOT APPLY TO YOU.

ALSO EXCLUDED FROM THIS WARRANTY ARE ANY INCIDENTAL OR CONSEQUENTIAL DAMAGES INCLUDING LOSS OF USE. SOME STATES DO NOT ALLOW THE EXCLUSION OR LIMITATION OF INCIDENTAL OR CONSEQUENTIAL DAMAGES; EXCLUSIONS MAY NOT APPLY TO YOU.

THIS WARRANTY GIVES YOU SPECIFIC LEGAL RIGHTS AND YOU MAY ALSO HAVE OTHER RIGHTS THAT VARY FROM STATE TO STATE.

FIRST-LIGHT USA, LLC
WARRANTY AND SERVICE DEPARTMENT
205 S. Main Street, Seymour, IL 61875

Phone: 877.454.4450
Fax: 877.454.4420
Email: info@firstlight-usa.com

WHEN YOUR LIGHT DEPENDS ON IT.®

www.firstlight-usa.com