

FIRST·LIGHT[®]
USA



TORQ[™] LE

USER MANUAL

TABLE OF CONTENTS

Specifications	2
Components	4
Battery Installation	5
Basic Functions	6
Lockout/Ready Mode	6
Momentary Mode	6
Primary Control	7
Secondary Control	7
Secondary Color	7
Strobe Mode	8
Safety Beacon Mode	8
Double-Click For Color	8
Low Battery Indication	9
Head Rotation	9
Finger Loop	9
Removable Side Panels	9
TRS Belt Mount	10
Accessories	10
Lifetime Limited Warranty	11

Thank you for purchasing the First-Light USA TORQ™ LE Tactical Light. Please carefully review this manual prior to use.



IMPORTANT – PLEASE READ FIRST

The intense white light emitted by the primary white LED may cause temporary blinding, regardless of the brightness level used. Use caution during operation. Do not point light directly into eyes at any distance. Not for use by children.

FIRST-LIGHT USA, LLC

205 S. Main Street
Seymour, IL 61875







Phone: 877.454.4450

Fax: 877.454.4420



Email: info@firstlight-usa.com

www.firstlight-usa.com

SPECIFICATIONS

FL1 STANDARD	MAX	HIGH
	155 LUMENS	114 LUMENS
	10h*	10h 45m
	116m	
	3,400cd	
	IPX-4, Water Resistant	
	3m	

** Runtime until output drops below 10% of maximum output at this setting.*

FL1 STANDARD	MEDIUM	LOW
	18 LUMENS	2 LUMENS
	33h	152h

Environmental Specifications

- Normal Operating Temperatures: (-20°F) to 120°F
- Water Resistant

Batteries

- (2) AA Batteries

COMPONENTS

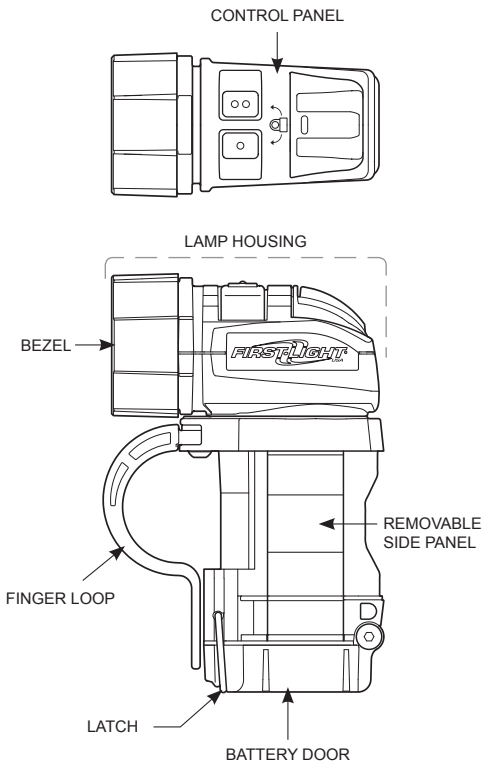

NOTE: Any user disassembly will void the warranty.

BATTERY INSTALLATION

STEP 1. Open battery door by releasing the latch (as shown below).

STEP 2. Insert two AA batteries according to polarity as indicated on the inside of battery door.

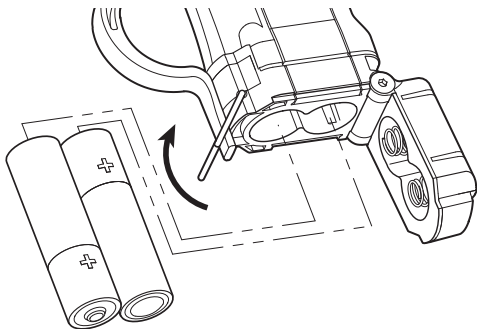

STEP 3. Close battery door insuring latch is secure.



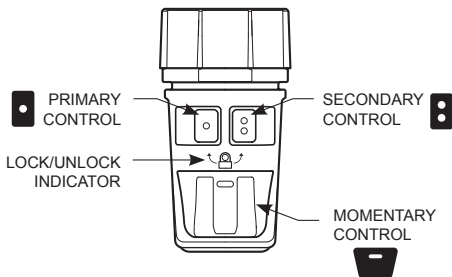

BASIC FUNCTIONS



LOCKOUT/READY MODE



The TORQ™ LE is factory-shipped in Lockout Mode, a setting for preventing accidental illumination. To unlock the light and enter Ready Mode, press the  and  buttons simultaneously and release. The green “unlock” indicator illuminates signaling that visible light modes are active.

To re-enter Lockout Mode at any time during use, press and hold the  and  buttons simultaneously until the red “lockout” indicator illuminates, then release.

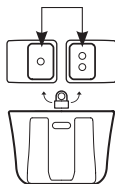
PRIMARY / SECONDARY CONTROLS





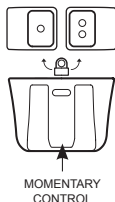

MOMENTARY CONTROL BUTTON

Pressing the  button will turn on the white LED in maximum output. Releasing the  button will turn off the white LED.





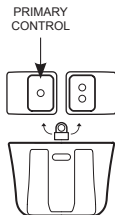

PRIMARY CONTROL BUTTON

To turn on the primary (white) LED, press and release the  button. To adjust the brightness of the primary LED, from the on position, press and hold the  button. Release the  button at the desired brightness. To turn off the primary LED, press and release the  button.



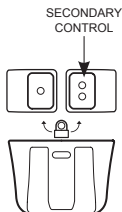

SECONDARY CONTROL BUTTON

To turn on the secondary (color) LEDs, press and release the  button. To adjust the brightness of the secondary LEDs, press and hold the  button. Release the  button at the desired brightness. To turn off the secondary LEDs, press and release the  button.



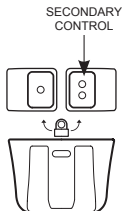

SECONDARY COLOR SELECTION

From the off position, press and hold the  button to cycle between the secondary LED color options. Release the  button at the desired color.





STROBE MODE

To turn on the strobe, press and hold the  button with the base of the thumb, then simultaneously press the  button with the front portion of the same thumb. Once the strobe is on, the  button may be released.

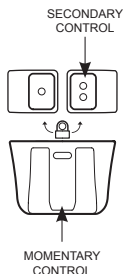
NOTE: Strobe Mode can only be activated as a momentary function.



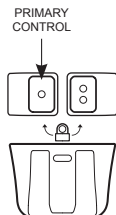

SAFETY BEACON MODE

To turn on the safety beacon, ensure that the light is in the off position. Press and hold the  button until the safety beacon is activated. To turn off the safety beacon, press and release the  button.



DOUBLE-CLICK FOR COLOR

While in Lockout Mode the colored LEDs can be activated by double-clicking the  button. This illuminates the secondary color LEDs in the lowest brightness setting and disables the primary white LED. Adjust the brightness by pressing and holding the  button. When the color LEDs are turned off, the light will return to Lockout Mode.

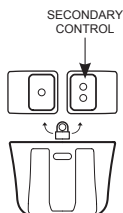

LOW BATTERY INDICATION

When the battery nears the end of its useful life the red Lock/Unlock indicator will begin to flash. Once the useful life of the batteries has been reached the TORQ™ LE will begin to limit its output in order to extend run time.



HEAD ROTATION

The TORQ LE's head is designed to rotate 320 degrees (160 degrees left or right of forward position).

FINGER LOOP

The TORQ LE finger loop is adjustable; however, it is not designed to be removed. Removing the finger loop will void the warranty.

REMOVABLE SIDE PANELS

Your TORQ LE comes equipped with removable side panels. To remove/reposition the side panels, open the battery door and slide out the side panel. Once repositioned, close battery door to lock into place. This feature enables the belt clip to be positioned on either side of your TORQ LE to accommodate a right or left hand carry preference.

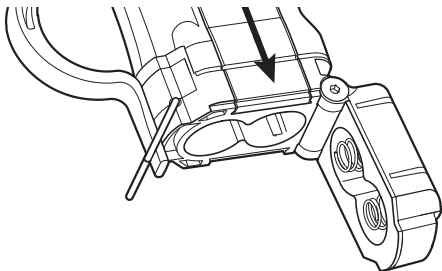

TRS BELT MOUNT (IF EQUIPPED)

The TRS Belt Mount allows the TORQ™ LE to be mounted to a duty belt (maximum width 2.25”).

To mount the TORQ LE to the TRS Belt Mount, insert the dovetail on the TORQ LE's side panel into the TRS Belt Mount until a “click” is heard to ensure proper seating. To release, push the spring-loaded button located at the top of the mount, then slide the dovetail connection free.



ACCESSORIES

Additional Side Panels are available for purchase. A TORQ™-compatible Tactical Retention System (TRS) dovetail connection is included with First-Light USA TRS mounting accessories. A Magnetic Side Panel along with a Strap Cutter and Bottle Opener are also available. Visit www.firstlight-usa.com for the latest information.

FIRST-LIGHT USA, LLC 2-YEAR LIMITED WARRANTY

The PERIOD OF WARRANTY shall be for two years from date of purchase of the lighting device. First-Light USA will repair or replace, free of charge, at First-Light USA's option, any part due to defects in materials or workmanship. First-Light USA, at First-Light USA's option, may refund the purchase price to the original owner if unable to make the product perform the work for which it was designed by repair or replacement of a product of at least equal value. The limited warranty contained herein is the purchaser's exclusive remedy.

THIS WARRANTY EXCLUDES damage or defects caused by neglect, abuse, misuse, alteration, disassembly, improper maintenance or accidents. Batteries, or damaged caused by defective or neglected batteries are excluded from this warranty.

Accessory items are also excluded from this warranty.

To obtain warranty service, call 877.454.4450 or send e-mail to: info@firstlight-usa.com

First-Light USA will then issue a Return Merchandise Authorization (RMA) and instructions on warranty return. The original owner must include the RMA upon returning the product in order to obtain warranty service from First-Light USA. We will pay to ship the repaired or replaced product to the original owner's address if located within United States. If the original owner's address is located outside of the United States, we will ship the product freight collect. If we determine the remedy is not covered under this warranty, we will notify you and inform you of service options available on a fee basis.

FIRST-LIGHT USA, LLC MAKES NO OTHER WARRANTY OF ANY KIND, EXPRESSED OR IMPLIED. ALL IMPLIED WARRANTIES, TO INCLUDE BUT NOT LIMITED TO WARRANTIES OF MERCHANTABILITY AND FITNESS FOR A PARTICULAR PURPOSE WHICH EXCEED THE OBLIGATIONS AND TIME LIMITS STATED IN THIS WARRANTY ARE HEREBY DISCLAIMED BY FIRST-LIGHT USA, LLC AND EXCLUDED FROM THIS LIMITED WARRANTY. SOME STATES DO NOT ALLOW LIMITATIONS ON HOW LONG AN IMPLIED WARRANTY LASTS, SO THE ABOVE LIMITATION MAY NOT APPLY TO YOU. ALSO EXCLUDED FROM THIS WARRANTY ARE ANY INCIDENTAL OR CONSEQUENTIAL DAMAGES INCLUDING LOSS OF USE. SOME STATES DO NOT ALLOW THE EXCLUSION OR LIMITATION OF INCIDENTAL OR CONSEQUENTIAL DAMAGES; EXCLUSIONS MAY NOT APPLY TO YOU. THIS WARRANTY GIVES YOU SPECIFIC LEGAL RIGHTS AND YOU MAY ALSO HAVE OTHER RIGHTS THAT VARY FROM STATE TO STATE.

FIRST-LIGHT USA, LLC
WARRANTY AND SERVICE DEPARTMENT
205 S. Main Street, Seymour, IL 61875

Phone: 877.454.4450
Fax: 877.454.4420
Email: info@firstlight-usa.com

WHEN YOUR LIGHT DEPENDS ON IT.®

www.firstlight-usa.com